

「금형사출 | MD상품 | 머천다이징 상품 | 봉제인형 | 무드등 | 스피커」

PRIDI
CONZ

(주) 프리디아이컨즈

차별화된
제품디자인

고퀄리티의
제품

자사가 보유한
특허기술

고객만족



(주)3d icons 대표이사
배은성

대한민국 NO.1 피규어 전문 제작 업체입니다.

2014년 6월 차세대 기술인 3D프린팅 사업으로 “세상에 하나뿐인 나만의 피규어”를 제작하며 피규어 사업에 첫걸음을 내디뎠습니다. 현재는 **국내 본사와 중국의 법인 지사 및 공장을 운영**하며 다양한 기업과 협약하여 각 기업의 이미지에 맞춰 피규어를 비롯한 다양한 MD상품을 제작합니다. 생활에서 충분한 가치를 갖는 캐릭터 제품을 실용성과 더 낮은 가격, 높은 품질로 제안함으로써 쓰리디아이컨즈만의 기술력으로 최상의 제품 제조를 하고 있습니다.

나 아니면 안 된다는 마음으로 대표와 직원들이 하나가 되어 정상을 향해 달려가고 있는 기업입니다. 쓰리디아이컨즈를 지지해주시는 고객과 구성원, 주주는 물론 모든 이해관계자의 행복을 위해 언제나 최선을 지향하겠습니다. 감사합니다.



피규어라는 틈새시장을 이용한 마케팅으로 쓰리디아이컨즈의 상품은 타기업과 다릅니다.

기업들의 상품 유출을 방지하기 위해 철저한 보안과 관리로 저희 쓰리디아이컨즈는 믿을 수 있습니다.

쓰리디아이컨즈는 피규어와 기존 상품을 결합하여 새로운 상품을 항상 개발합니다.



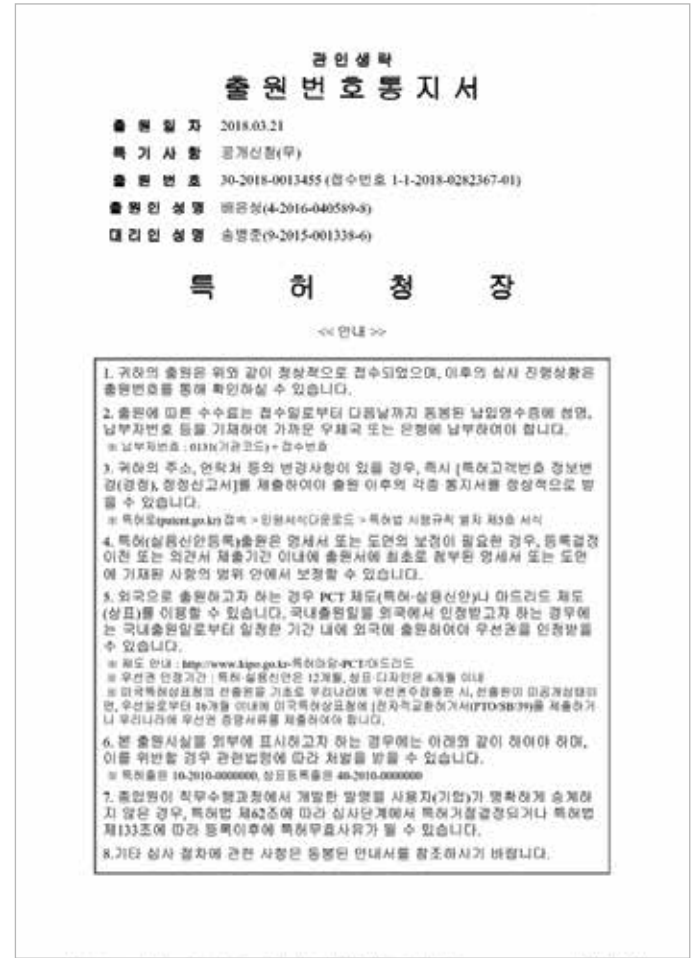
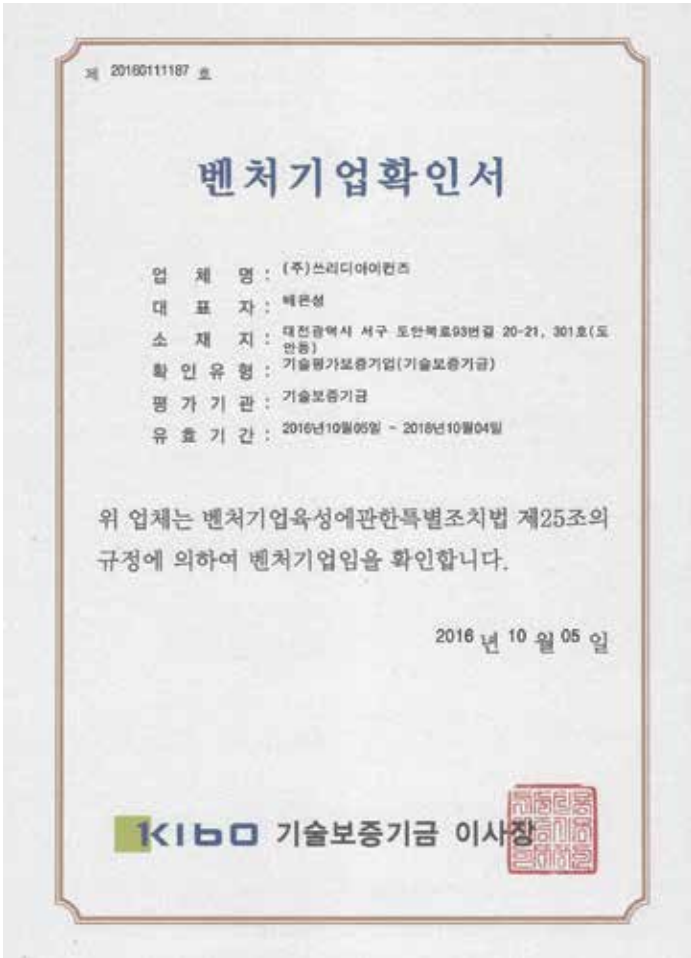



중국지사
및
중국·베트남 공장

(주)3D ICONS가 직접 운영하는
중국과 베트남 현지 공장입니다.
각 분야의 전문가들이
최상의 제품을 제작합니다.

HAT
MAN

YAWNING 

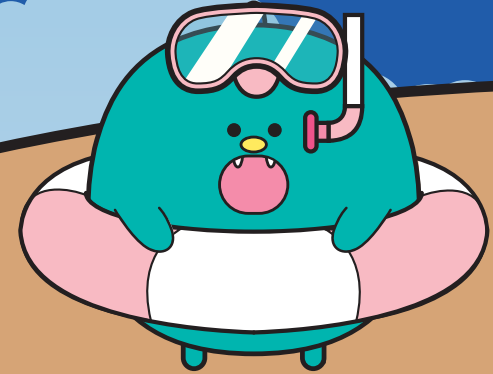
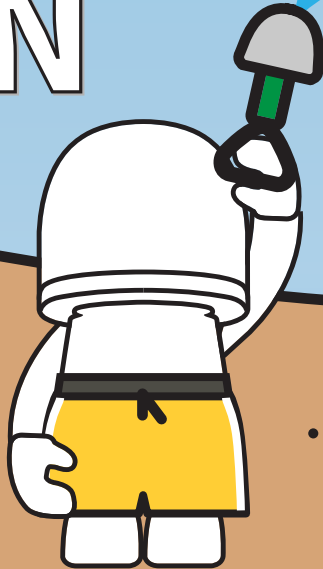

HATMAN & YAWNING

자사캐릭터 햇맨 & 야닝

햇맨과 야닝은 쓰리다아이컨즈의 캐릭터 라이선싱 사업의 콘텐츠 전략화 계획의 일환으로 개발하게 되었습니다.

캐릭터를 활용하여 이모티콘 및 MD사업까지 확장할 계획이며 다양한 제품으로 각양각색의 디자인을 제공합니다.

캐릭터가 다양한 제품과 만나 시너지 효과를 내는 캐릭터 마케팅을 쓰리다아이컨즈에서 만나보세요



ALTKEY만의 새로운 캐릭터 HATMAN(햇맨)은 모자 'HAT'과 사람 'MAN'의 합성어로 모자를 쓴 사람을 디자인 모티브로 하여 언제나 모자를 쓰고 있는 캐릭터입니다.

모자 브랜드 알트키(ALTKEY)의 캐릭터 '햇맨(HATMAN)' 부끄러움이 많은 성격 때문에 커다란 모자로 얼굴을 항상 가리고 다닙니다. 햇맨과 친구가 되어보세요. 친해지면 얼굴을 볼 수 있을지도 몰라요!

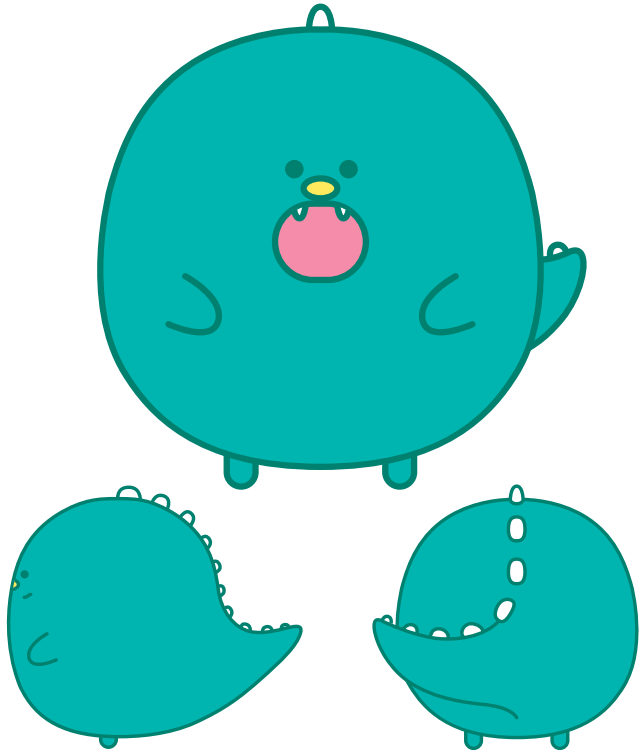

"야닝은 언제나 졸려"

이제 막 태어난 공룡 야닝은 몰려오는 졸음을 이기지 못해
하품을 늘 달고 다니는 캐릭터입니다.

잠으로 인해 가끔 짜증과 눈물을 보이곤 하지만

언제 그랬냐는 듯 다시 즐거운 야닝으로 돌아오기도 합니다.

귀여운 잠꾸러기 공룡 야닝을 통해 편안하고 따뜻한 감성을 느낄 수 있습니다.

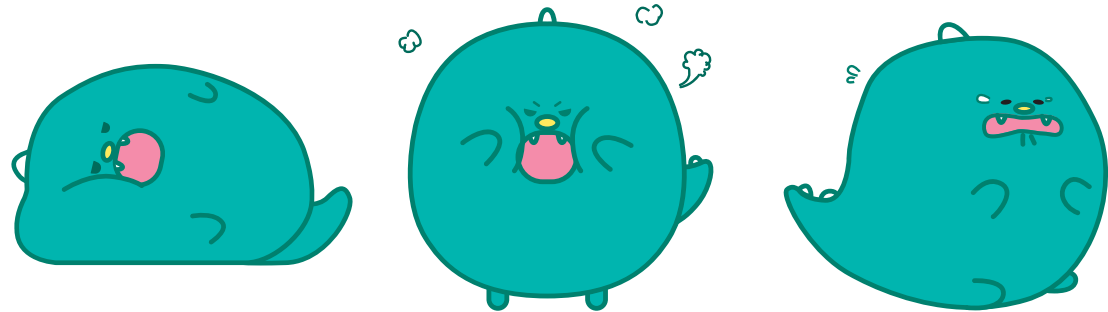

YAWNINGO 

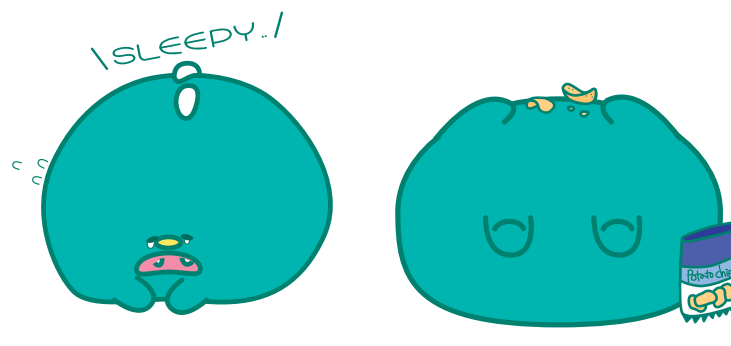

모자모듈

(특허 제품)

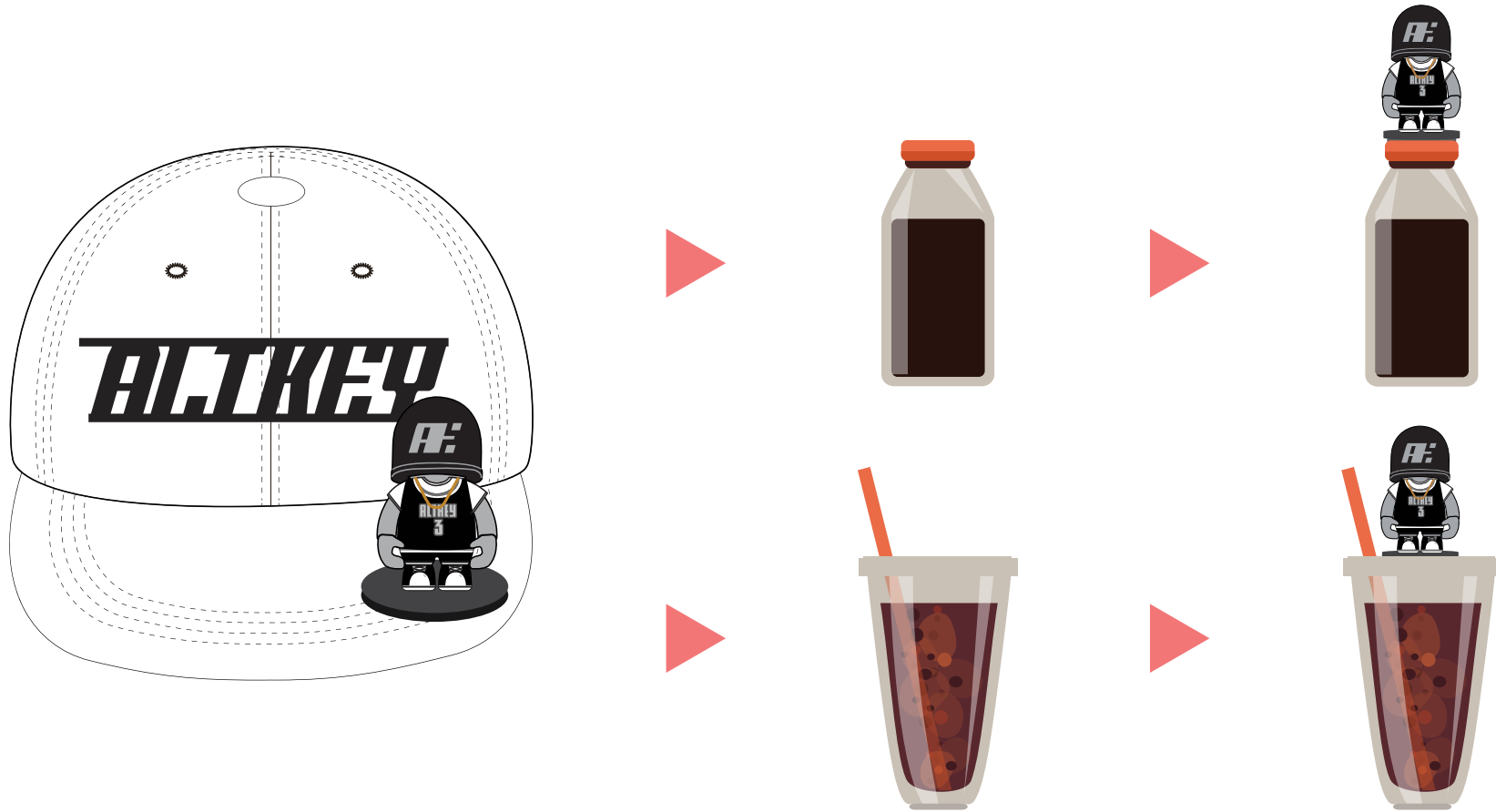

모자에 부착된 피규어는 교환 모듈을 이용하여 모자 뿐만 아니라 텀블러 등 교환 모듈이 부착되어 있는 제품에는 전부 호환이 가능합니다.



컵라면 뚜껑 덮개

(특허 제품)



컵 라면 뚜껑이 열리지 않게 눌러 주는 기능 뿐만 아니라 사용하는 젓가락의 위생을 보호해 줄수 있는 아이디어 제품입니다.

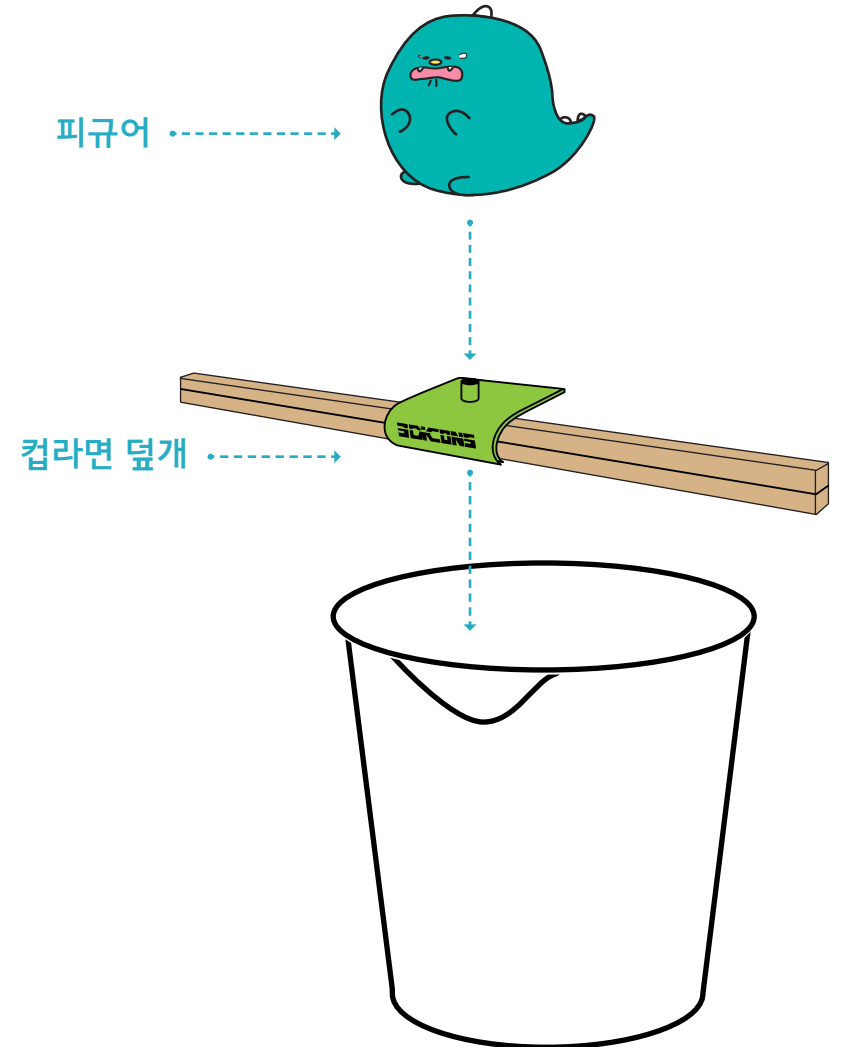

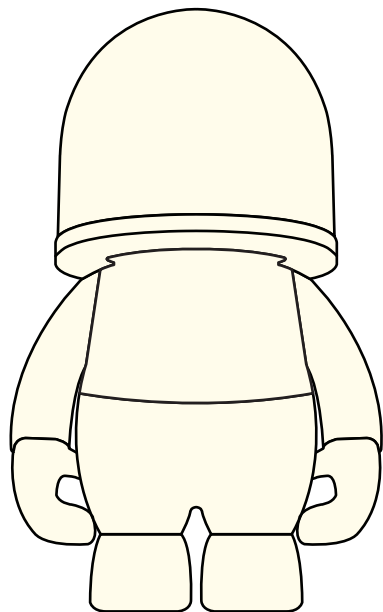

앞

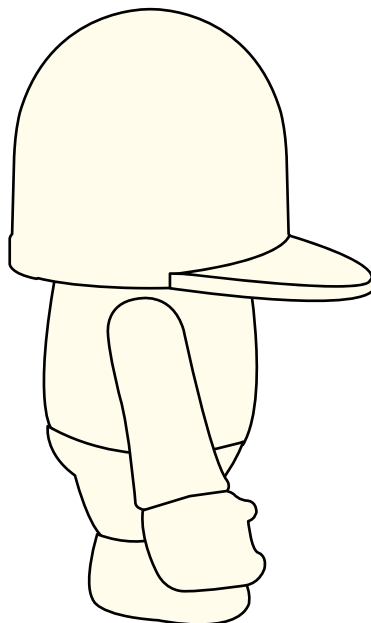

옆

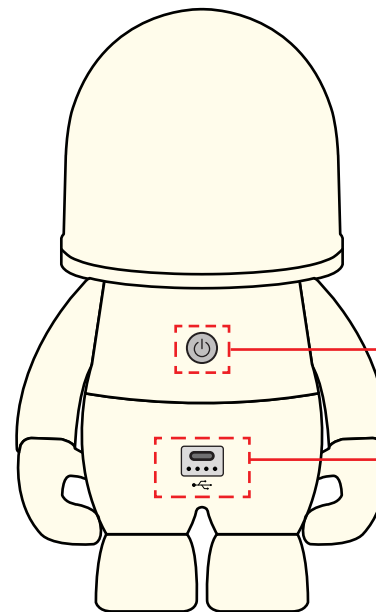

전원 버튼

충전단자
배터리 잔량 표시

뒤

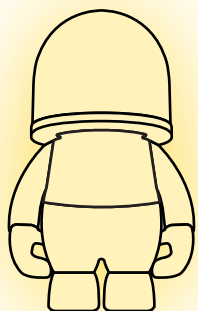

1단계

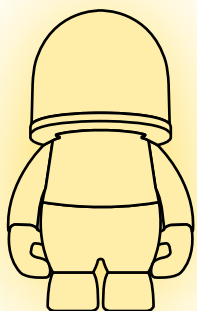

2단계

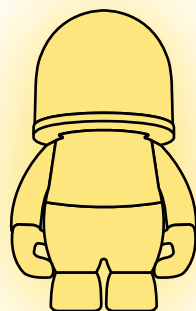

3단계

※앞, 옆, 뒤 모습이 모두 있어야 모델링이 가능합니다.



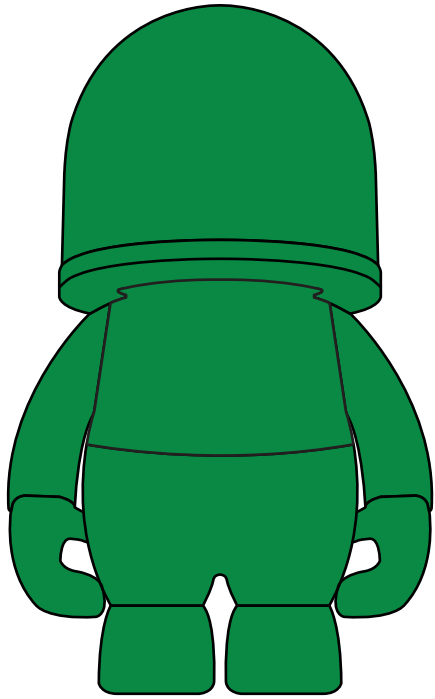

앞

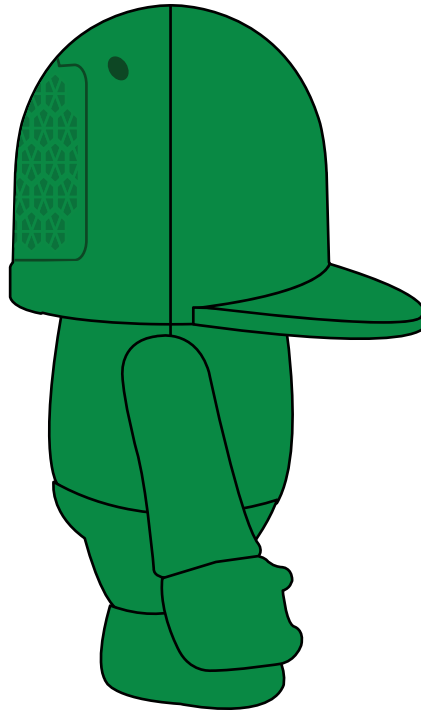

옆

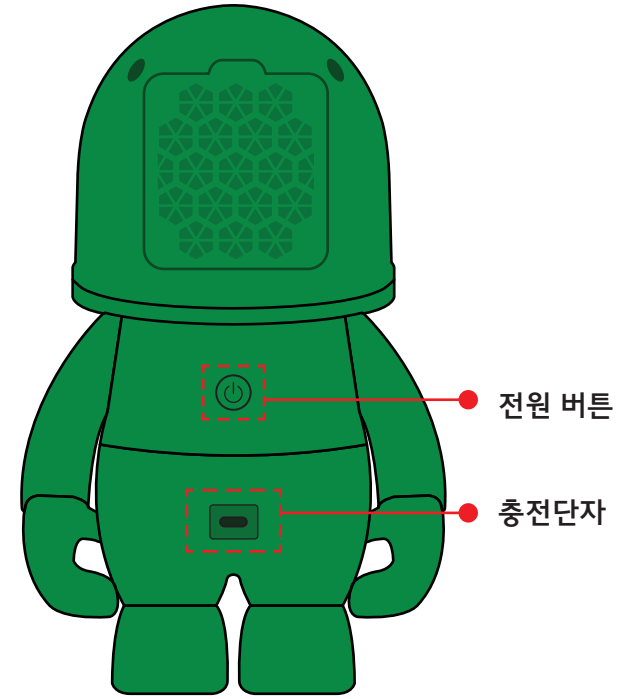

뒤

※앞, 옆, 뒤 모습이 모두 있어야 모델링이 가능합니다.



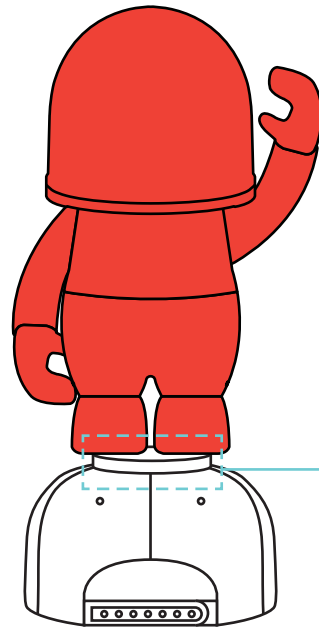
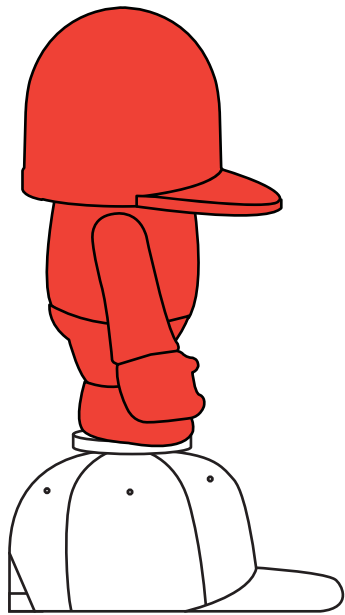
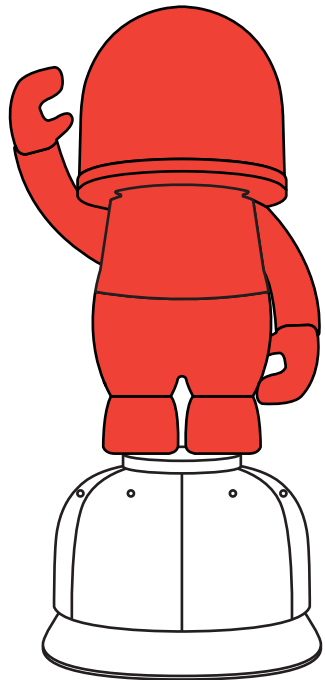

돌림판

테엽

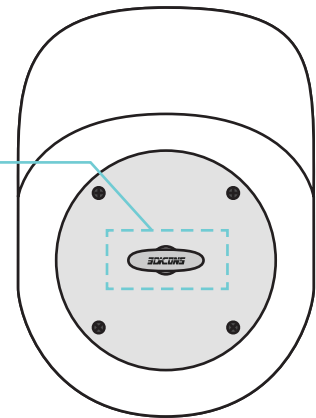





분리가능

리필 방향제
넣는 부분

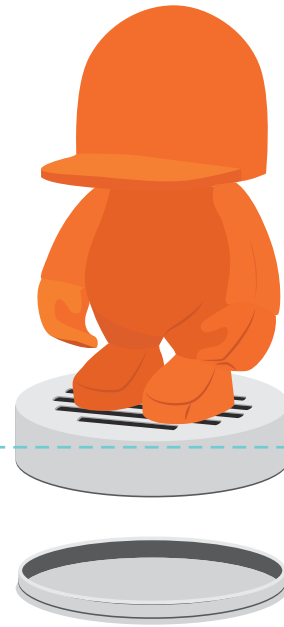

분리가능



시안1

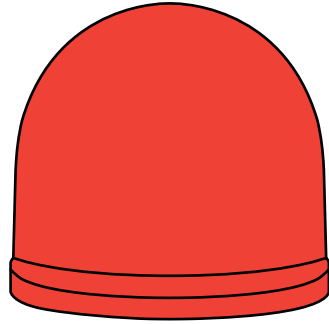

앞

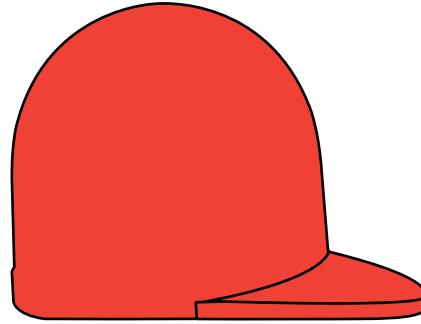

옆

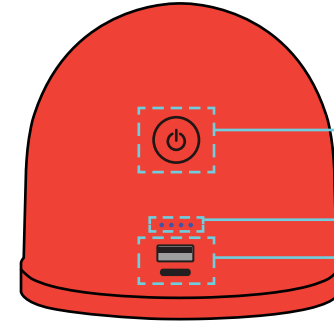

뒤

- 전원버튼
- 배터리 잔량
- 충전단자

시안2

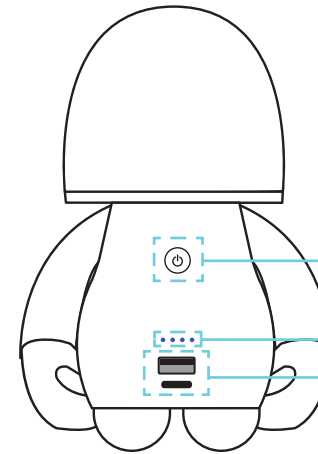
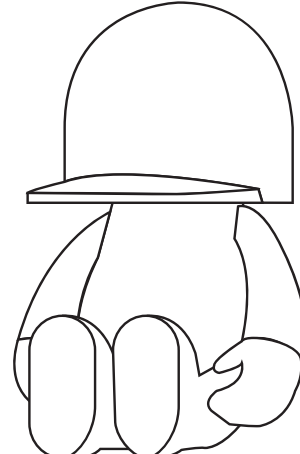
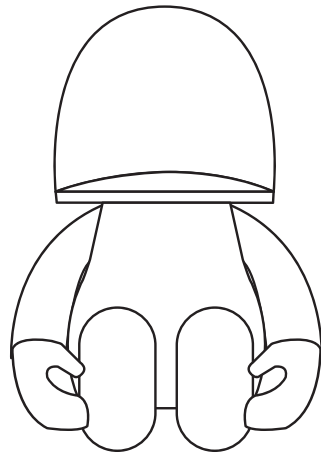

- 전원버튼
- 배터리 잔량
- 충전단자















 **JEJU UNITED**



3DICONS Co., Ltd

www.icons-3d.com

회 사 명 주식회사 쓰리디아이컨즈

대표이사 배은성

설 립 일 2014.06

본 사 대전시 서구 도안북로 93번길 25 센타프라자 B/D 3층

서울 지사 서울시 강남구 봉은사로 114길 32로 삼성동 우남빌딩 701호

중국 지사 Guangdong Dongguan-shi Qiaotou-zhen
Guangchangxierjie 1hao

호주 지사 Shop 16 / 16-20 Henley Rd
Homebush West NSW 2140 Australia

중국 공장 2RD Renxing, Beice Renhe Industrial,
humen town Dongguan Guangdong ,China

베트남공장 No.25, Street4, VSIP II Industrial Park,
Thu Dau Mot, Binh Duong Province, Vietnam

사업분야 금형사출 피규어 / 3D프린팅 피규어 / SHIFT 블립사업
ALTKEY 모자브랜드사업 / ENTER TOUR 여행사업

웹사이트 www.icons-3d.com